

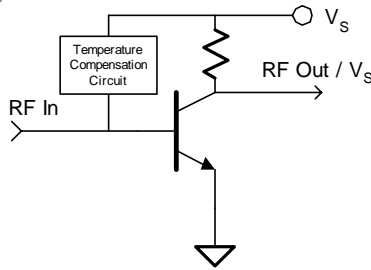

## Product Description

The SGL-0263 is a high performance SiGe HBT MMIC low noise amplifier featuring 1 micron emitters with  $F_T$  up to 50 GHz. This device has an internal temperature compensation circuit permitting operation directly from supply voltages as low as 2.5V. The SGL-0263 has been characterized at  $V_d = 3V$  for low power and 4V for medium power applications. Only 2 DC-blocking capacitors, 2 input matching components, a bias resistor, and an optional RF choke are required for operation from 1400-2500 MHz.

The matte tin finish on Sirenza's lead-free "Z" package is applied using a post annealing process to mitigate tin whisker formation and is RoHS compliant per EU Directive 2002/95. The package body is manufactured with green molding compounds that contain no antimony trioxide or halogenated fire retardants.



## SGL-0263

**SGL-0263Z**  RoHS Compliant & Green Package

## 1400 - 2500 MHz Silicon Germanium Cascadable Low Noise Amplifier



### Product Features

- Available in Lead Free, RoHS Compliant green package ( Z Suffix )
- High Input / Output Intercept
- Low Noise Figure: 1.3dB typ. at 1900 MHz
- Low Power Consumption
- Single Voltage Supply Operation
- Internal Temperature Compensation

### Applications

- Receivers, GPS, RFID
- Cellular, Fixed Wireless, Land Mobile

Symbol	Parameter	Freq. (MHz)	Min. ( $V_s=3V$ )	Typ. ( $V_s=3V$ )	Max. ( $V_s=3V$ )	Typ. ( $V_s=4V$ )	Units
G	Small Signal Gain	1900 2100 2400	12.1	13.4 12.5 10.8	14.7	13.8 12.9 11.3	dB
$P_{1dB}$	Output Power at 1dB Compression	1900 2100 2400	3.5	5.5 6.8 7.9		11.4 12.3 12.8	dBm
$IIP_3$	Input Third Order Intercept Point Tone Spacing = 1 MHz $P_{out}$ per tone = -13dBm	1900 2100 2400	7.5	9.5 13.5 15.5		15.1 16.8 18.4	dBm
NF	Noise Figure, $Z_s = 50$ Ohms	1900 2100 2400		1.3 1.5 2.0	1.7	1.9 2.1 2.8	dB
IRL	Input Return Loss	1900	10.0	13.3		21.9	dB
ORL	Output Return Loss	1900	10.0	12.9		17.4	dB
$ S_{12} $	Reverse Isolation	1900		20.7		21.0	dB
$I_d$	Device Current		9.0	12.5	15	23	mA
$R_{TH(j-l)}$	Thermal Resistance (junction to lead)			255			$^{\circ}C/W$
<b>Test Conditions: 1400-2500 MHz Application Circuit <math>T_{LEAD} = 25^{\circ}C</math> <math>Z_0 = Z_L = 50</math> Ohms</b>							

The information provided herein is believed to be reliable at press time. Sirenza Microdevices assumes no responsibility for inaccuracies or omissions. Sirenza Microdevices assumes no responsibility for the use of this information, and all such information shall be entirely at the user's own risk. Prices and specifications are subject to change without notice. No patent rights or licenses to any of the circuits described herein are implied or granted to any third party. Sirenza Microdevices does not authorize or warrant any Sirenza Microdevices product for use in life-support devices and/or systems. Copyright 2005 Sirenza Microdevices, Inc.. All worldwide rights reserved.

**Typical RF Performance Over Lead Temperature at 3 V and 4 V -- 1400-2500 MHz Evaluation Board**

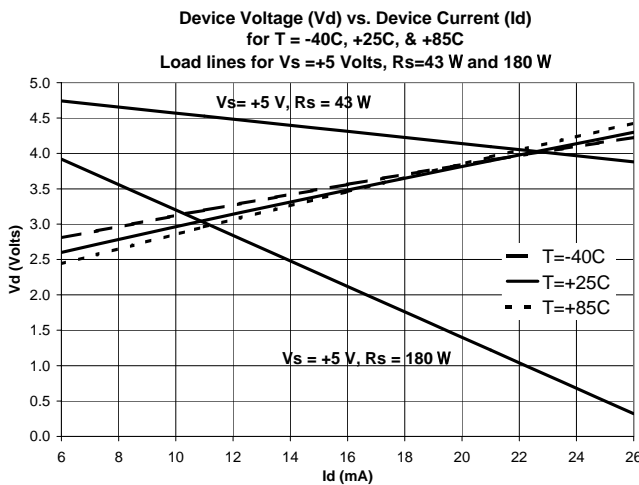
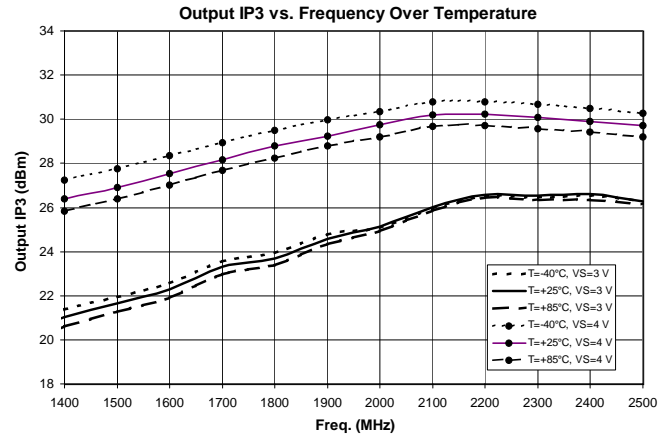
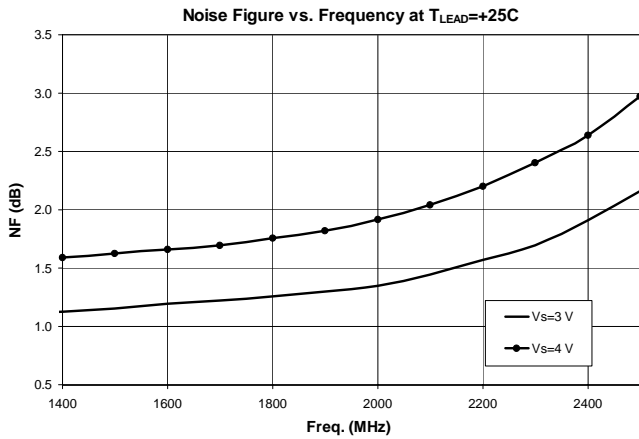
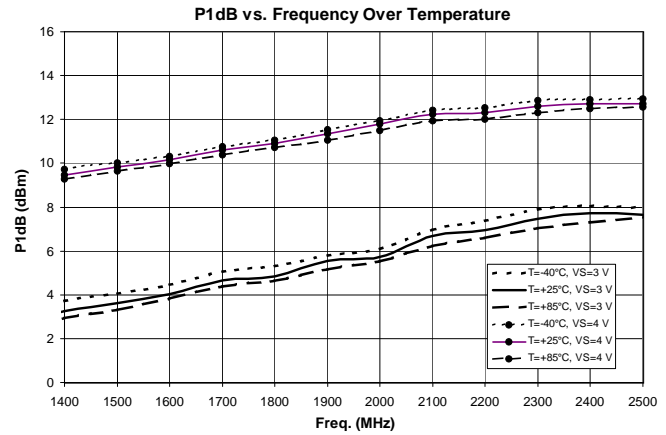
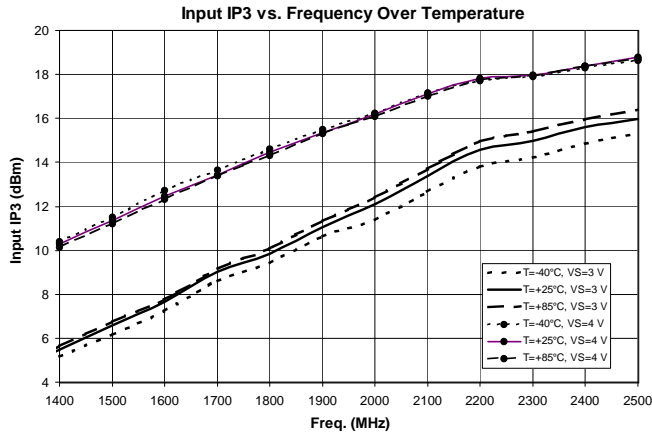

Absolute Maximum Ratings	
Parameter	Absolute Limit
Max. Device Current (I <sub>D</sub> )	45 mA
Max. Device Voltage (V <sub>S</sub> )	5 V
Max. RF Input Power	+10 dBm
Max. Junction Temp. (T <sub>J</sub> )	+150°C
Operating Temp. Range (T <sub>LEAD</sub> )	-40°C to +85°C
Max. Storage Temp.	+150°C

Operation of this device beyond any one of these limits may cause permanent damage. For reliable continuous operation, the device voltage and current must not exceed the maximum operating values specified in the table on page one.

Bias conditions should also satisfy the following expression:

$$I_D V_D < (T_J - T_{LEAD}) / R_{TH} \text{ } ^\circ\text{C/W}$$

**Typical RF Performance at  $V_s = 3\text{ V}$  -- 1400-2500 MHz Evaluation Board --  $T_{LEAD} = +25^\circ\text{C}$**

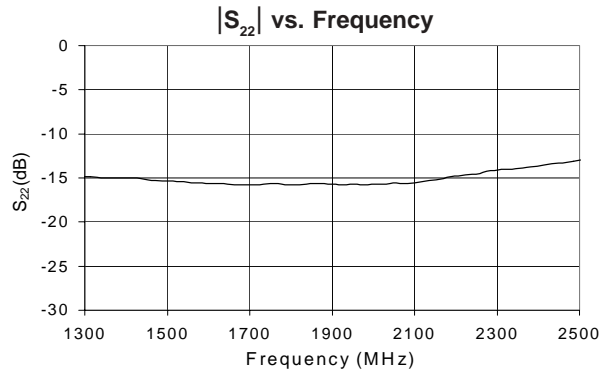
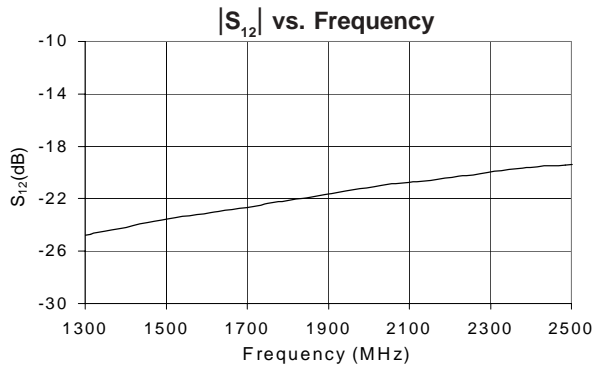
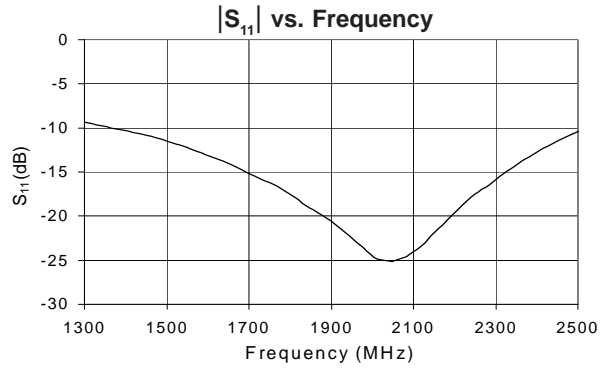
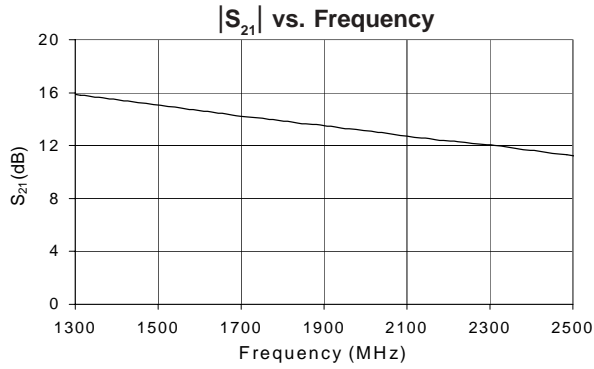

**Typical RF Performance at  $V_s = 4\text{ V}$  -- 1400-2500 MHz Evaluation Board --  $T_{LEAD} = +25^\circ\text{C}$**

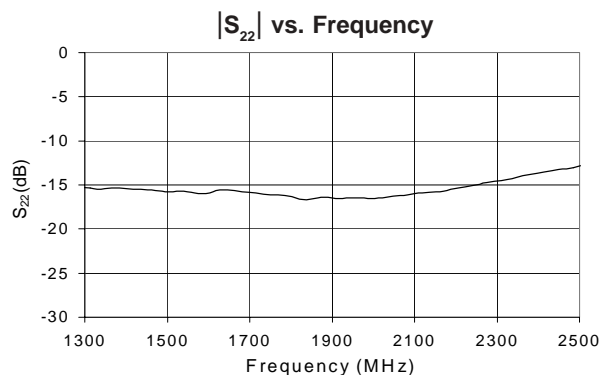
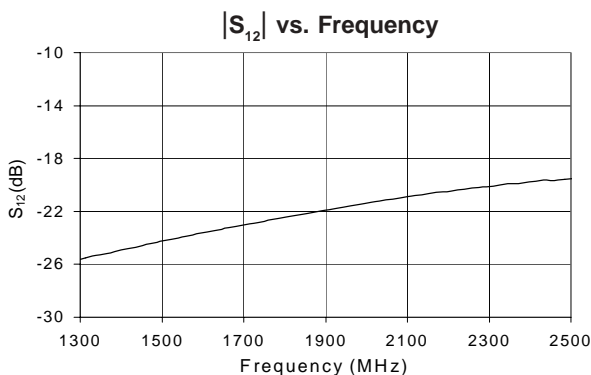
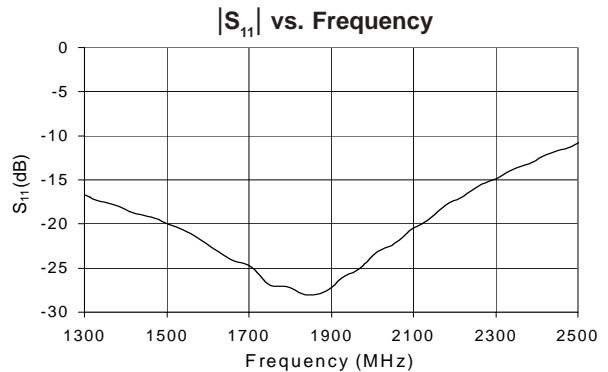
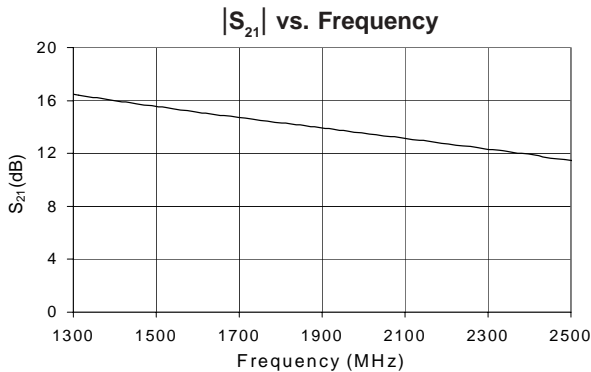

NOTE: Full S-parameter data available at [www.sirenza.com](http://www.sirenza.com)

**1400-2500 MHz Application Circuit**

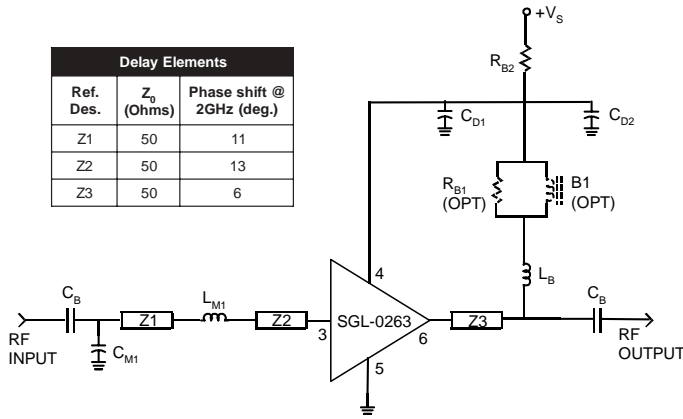

**1400-2500 MHz Evaluation Circuit Board**

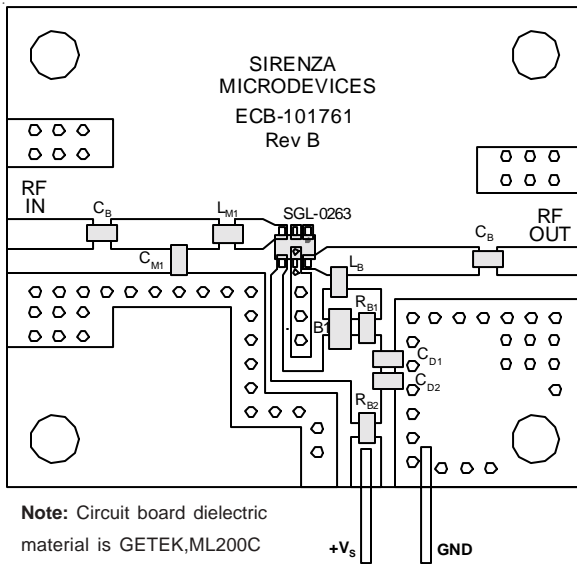

**Application Circuit Element Values**

Reference Designator	Value	Manufacturer & Part No.
L <sub>B</sub>	27 nH	TOKO LL1608-FS27NJ
L <sub>M1</sub>	1.2 nH	TOKO LL1608-FS1R2NJ
B1 <sup>1</sup>	1500 Ohms @100 MHz Ferrite Bead	FAIR-RITE 2508051527y0
C <sub>B</sub> , C <sub>D1</sub>	0.1 uF	SAMSUNG CL10B103KBNC
C <sub>D2</sub>	22 pF	ROHM MCH185AA220DJK
C <sub>M1</sub>	1.0 pF	ROHM MCH185A1R0CK
R <sub>B1</sub> <sup>1</sup>	47 Ohms	PHILLIPS 9C06031A47R0 JL HFT
R <sub>B2</sub> <sup>2</sup>	0 Ohms	PHILLIPS 9C06031A0R00 JL HFT

**Notes:**

- B1 and R<sub>B1</sub> provide improved K-factor but are optional.
- R<sub>B2</sub> may be introduced as a voltage dropping resistor for use with supply voltages greater than the desired device bias voltage.

**Device Pin Out Guide**

Pin #	Function	Description
1	N/C	No electrical connection. Provide an isolated (un-grounded) solder pad for mounting integrity.
3	RF IN	RF input pin. This pin requires the use of an external DC blocking capacitor chosen for the frequency of operation.
4	DC BIAS	Voltage supply connection. Bypass with suitable capacitors.
2, 5	Ground	Connection to ground. Provide via holes as close to the device ground leads as possible to reduce ground inductance and achieve optimum RF performance.
6	RF OUT/BIAS	RF output and voltage supply. DC voltage is present on this pin, therefore a DC blocking capacitor is necessary for proper operation.

**Part Identification Marking & Pin Out**

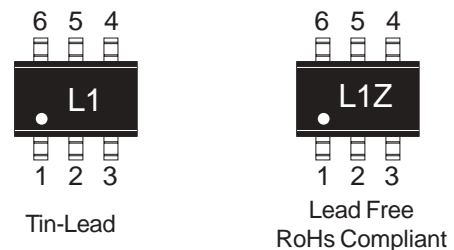

**Reliability & Qualification Information**

Parameter	Rating
ESD Rating - Human Body Model (HBM)	Class 1A
Moisture Sensitivity Level	MSL 1

The product qualification report may be downloaded at [www.sirenza.com](http://www.sirenza.com)



**Caution: ESD sensitive**  
Appropriate precautions in handling, packaging and testing devices must be observed.

**Part Ordering Information**

Part Number	Package / Lead Composition	Reel Size	Devices / Reel
SGL-0263	Tin-Lead	7"	3000
SGL-0263Z	Lead Free, RoHs Compliant	7"	3000

**SOT-363 PCB Pad Layout**

Dimensions in inches [millimeters]

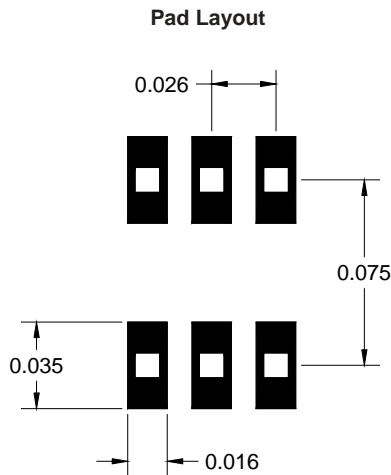

Notes:

1. Provide a ground pad area under device pins 2 & 5 with plated via holes to the PCB ground plane.
2. We recommend 1 or 2 ounce copper. Measurements for this data sheet were made on a 31 mil thick Getek with 1 ounce copper on both sides.

**SOT-363 Nominal Package Dimensions**

Dimensions in inches [millimeters]

A link to the SOT-363 package outline drawing with full dimensions and tolerances may be found on the product web page at [www.sirenza.com](http://www.sirenza.com).

